

1591C ENCLOSURE

LID FASTENERS
M3 x 10 mm Screws for FRABS/Polycarb
#4 x 1/2" Self Tapping for GPABS

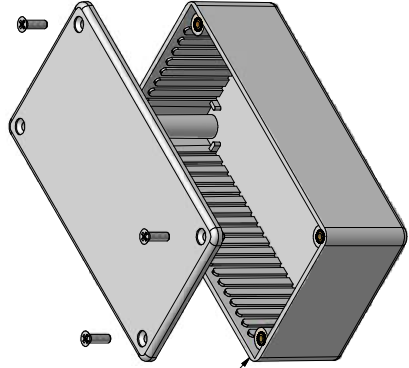

Brass inserts in FRABS and Polycarb -
No inserts in GPABS

EXPLODED VIEW OF ENCLOSURE

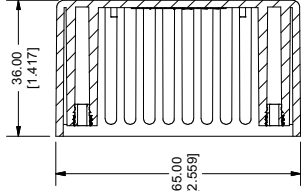

SECTION B-B

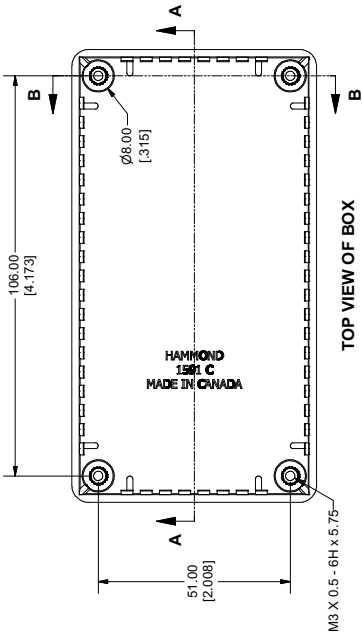

SIDE VIEW OF BOX

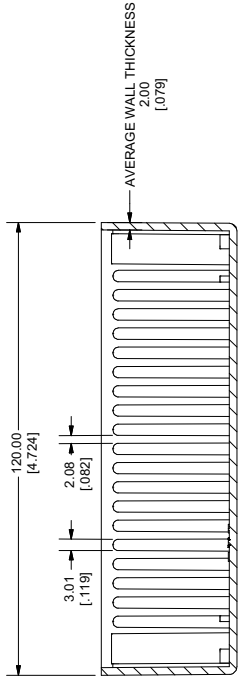

SECTION A-A

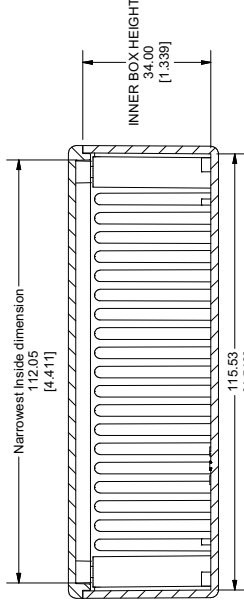

SECTION C-C

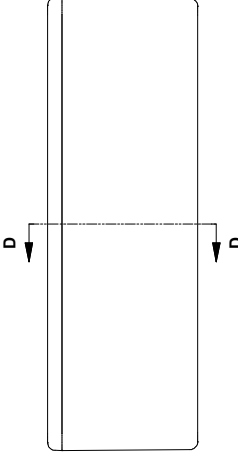

SECTION D-D

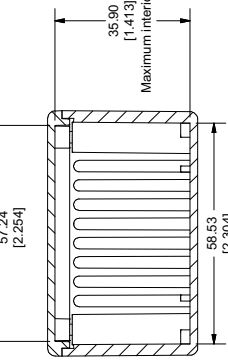

SECTION D-D

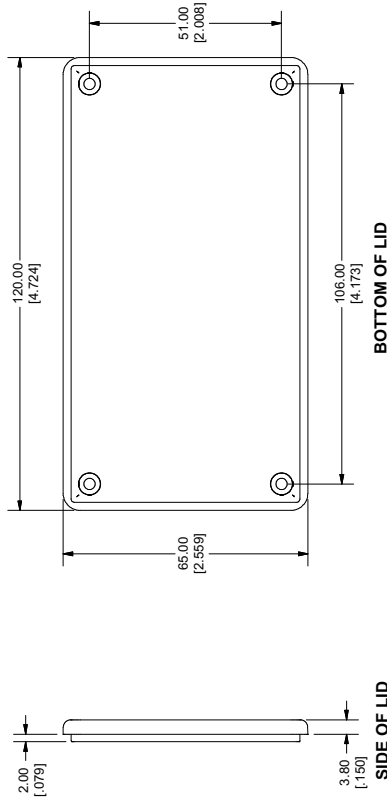

BOTTOM OF LID

SIDE OF LID

PART NUMBERS

1591C Enclosures	
Material	Part Number
FR ABS	1591CBK
UL94 - V0	1591CGY
GP ABS	1591RCSBK
	1591CSBK
	1591CSGY
Translucent Polycarbonate	1591CTBU
	1591CTRD
	1591CTOL
Accessories	
Description	Part Number
PC Board Card Adapters	See Accessories Section
Flange Kits	See Accessories Section
Clear Lids - clear, flame retardant polycarbonate - Lid ONLY	1591CC
FR ABS & Polycarbonate Replacement Screws: Flat head Phillips, Nickel	1591MS100
Polycarbonate Plated Pkg of 100	1591MS100BK (Black)
GP ABS Self Tapping Pkg of 100	1591TS100
	1591TS100BK (Black)
Required Torque on Fasteners (no lubrication)	
M3 - 0.5 x 10mm Screws	30-40 cN·m
#4 x 0.5" Screws	30-40 cN·m

Note:
Enclosures can be Factory Modified (Milling, Drilling, Printing etc.)
Solid models of this enclosure available in STEP or IGES Format.
Contact Factory mjm@hammondmg.com

