

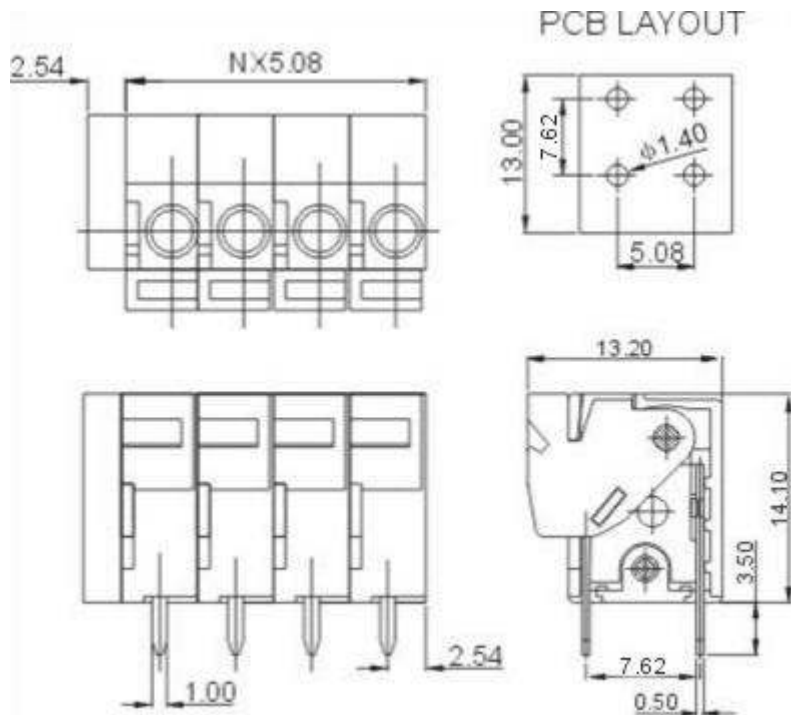



**DG142V-5.08**

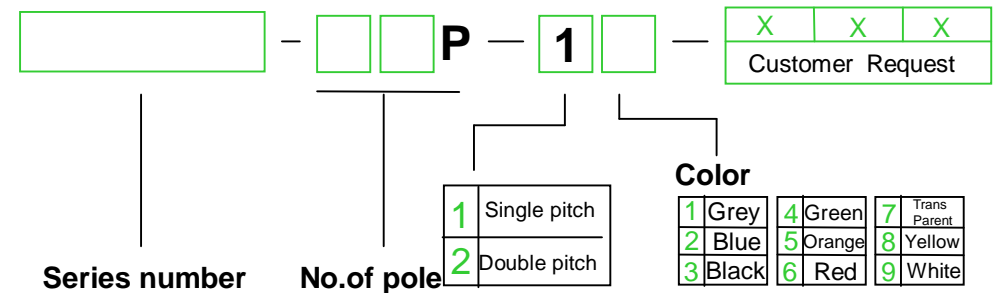

<b>Approval</b>		
<b>Electrical</b>		
<b>Standard</b>	<b>UL</b>	<b>IEC</b>
Rated voltage	300V	250V
Rated current	10A	15A
Wire range	22-16AWG	0.2-1.5mm <sup>2</sup>
Withstanding voltage	AC2000V/1Min	
<b>Mechanical</b>		
Ambient temperature	-40°C ~ +105 °C	
Strip length	10mm	
<b>Dimensions</b>		
Pitch	5.08mm(.200" )	
Poles	1P-XXP	
<b>Material</b>		
Housing	PA66,UL94V-0	
Pin header	Brass,Tin plated	
Wire guard	Stainless steel	

### HOW TO ORDER :

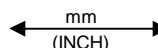

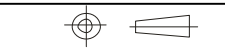
 mm (INCH)	 <b>DEGSON ELECTRONICS CO., LTD.</b>
 THROANGLE    PROJECTION	<b>NAME</b> <b>DG142V-5.08</b>