



95.05

Relay type	40.31		40.51/ 52/ 61	
Colour	BLUE	BLACK	BLUE	BLACK
Clamp terminal socket: panel or 35 mm rail (EN 50022) mount, retaining clip 095.01 supplied with socket packaging code SPA	95.03	95.03.0	95.05	95.05.0
Plastic retaining and release clip	095.01	095.01.0	095.01	095.01.0
Metal retaining clip	095.71			
8-way jumper link for 95.03 and 95.05 sockets	095.18	095.18.0	095.18	095.18.0
Identification tag	095.00.4			
Modules (see table below)	99.02			
Timer modules (see table below)	86.10, 86.20			
Sheet of marker tags for retaining and release clip 095.01	060.72			

40

Approvals (according to type):



- Rated values: 10 A - 250 V with a current >10 A, the contact terminal must be connected in parallel (21 with 11, 24 with 14, 22 with 12)
- Insulation: ≥ 6 kV (1.2/50 μ s) between coil and contacts
- Protection category: IP 20
- Ambient temperature: (-40...+70) $^{\circ}$ C
- Screw torque: 0.5 Nm
- Wire strip length: 8 mm
- Max wire size:

	solid wire	stranded wire
mm ²	1x6 / 2x2.5	1x4 / 2x2.5
AWG	1x10 / 2x14	1x12 / 2x14

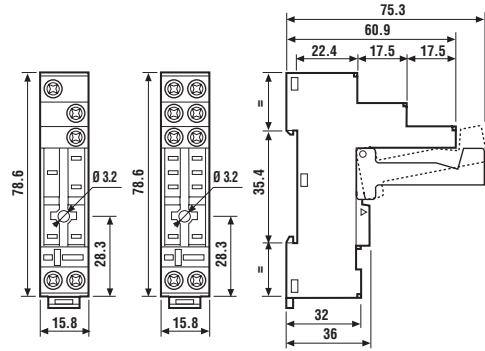

095.01



060.72

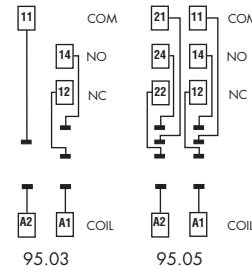

FOR 95.03 AND 95.05 SOCKETS:



095.18

8-way jumper link	095.18
--------------------------	--------

- Rated values: 10 A - 250 V

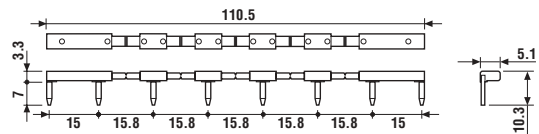

86.10

86 series module timers (see technical data pages 151/156)	BLUE
Mono-function: (12...24)V AC/DC; function AI; (1.5s...60min)	86.10.0.024.0000
Mono-function: (12...24)V AC/DC; function DI; (1.5s...60min)	86.20.0.024.0000

Approvals (according to type): GOST



99.02

Approvals (according to type):



99.02 coil indication and EMC suppression modules (see technical data page 209)		BLUE*
Diode** (+A1, standard polarity)	(6...220)V DC	99.02.3.000.00
LED	(6...24)V DC/AC	99.02.0.024.59
LED	(28...60)V DC/AC	99.02.0.060.59
LED	(110...240)V DC/AC	99.02.0.230.59
LED + Diode** (+A1, standard polarity)	(6...24)V DC	99.02.9.024.99
LED + Diode** (+A1, standard polarity)	(28...60)V DC	99.02.9.060.99
LED + Diode** (+A1, standard polarity)	(110...220)V DC	99.02.9.220.99
LED + Varistor	(6...24)V DC/AC	99.02.0.024.98
LED + Varistor	(28...60)V DC/AC	99.02.0.060.98
LED + Varistor	(110...240)V DC/AC	99.02.0.230.98
RC circuit	(6...24)V DC/AC	99.02.0.024.09
RC circuit	(28...60)V DC/AC	99.02.0.060.09
RC circuit	(110...240)V DC/AC	99.02.0.230.09
Residual current by-pass (62 k Ω /1W)	(110...240)V AC	99.02.8.230.07

* Modules in Black housing are available on request.

**For DC supply, apply the positive to terminal A1.



95.85.3

Approvals
(according to type):



GOST

- Rated values: 10 A - 250 V
with a current >10 A, the contact terminal must be connected in parallel (21 with 11, 24 with 14, 22 with 12)
- Insulation: ≥ 6 kV (1.2/50 μ s)
between coil and contacts (only for 95.83.3)
- Protection category: IP 20
- Ambient temperature: (-40...+70)°C
- Srew torque: 0.5 Nm
- Wire strip length: 7 mm
- Max wire size:

	solid wire	stranded wire
mm ²	1x6 / 2x2.5	1x4 / 2x2.5
AWG	1x10 / 2x14	1x12 / 2x14

Relay type	40.31		40.51, 40.52, 40.61	
Colour	BLUE	BLACK	BLUE	BLACK
Clamp terminal socket: panel or 35 mm rail (EN 50022) mount retaining clip 095.91.3 supplied with socket packaging code SPA	95.83.3	95.83.30	95.85.3	95.85.30
Metal retaining clip	095.71			
Plastic retaining and release clip	095.91.3			
8-way jumper link for 95.83.3 and 95.85.3 sockets	095.08	095.08.0	095.08	095.08.0
Modules (see table below)	99.80			
Sheet of marker tags for retaining and release clip 095.91.3	060.72			

40

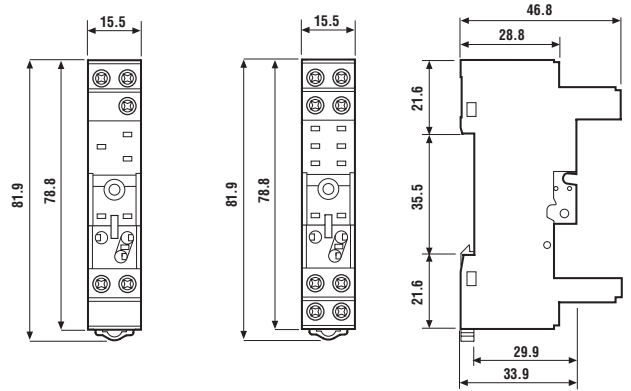

095.91.3



060.72

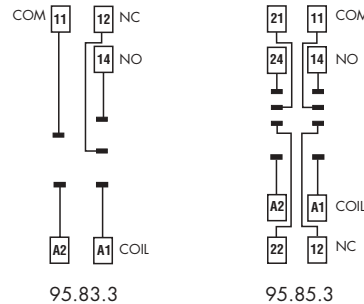

FOR 95.83.3 AND 95.85.3 SOCKETS:



095.08

8-way jumper link	095.08
--------------------------	--------

- Rated values: 10 A - 250 V

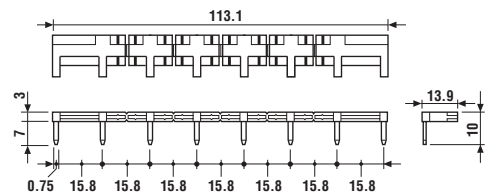

99.80

Approvals
(according to type):

GOST

* Modules in Black housing are available on request.

**For DC supply, apply the positive to terminal A1.

Green LED is standard.
Red LED available on request.

99.80 coil indication and EMC suppression modules (see technical data page 209)		BLUE*
Diode** (+A1, standard polarity)	(6...220)V DC	99.80.3.000.00
LED	(6...24)V DC/AC	99.80.0.024.59
LED	(28...60)V DC/AC	99.80.0.060.59
LED	(110...240)V DC/AC	99.80.0.230.59
LED + Diode** (+A1, standard polarity)	(6...24)V DC	99.80.9.024.99
LED + Diode** (+A1, standard polarity)	(28...60)V DC	99.80.9.060.99
LED + Diode** (+A1, standard polarity)	(110...220)V DC	99.80.9.220.99
LED + Varistor	(6...24)V DC/AC	99.80.0.024.98
LED + Varistor	(28...60)V DC/AC	99.80.0.060.98
LED + Varistor	(110...240)V DC/AC	99.80.0.230.98
RC circuit	(6...24)V DC/AC	99.80.0.024.09
RC circuit	(28...60)V DC/AC	99.80.0.060.09
RC circuit	(110...240)V DC/AC	99.80.0.230.09
Residual current by-pass (62 k Ω /1W)	(110...240)V AC	99.80.8.230.07



Relay type	40.31, 40.41		40.51, 40.52, 40.61	
Colour	BLUE	BLACK	BLUE	BLACK
P.C.B. socket	95.13.2	95.13.20	95.15.2	95.15.20
retaining clip 095.51 supplied with socket packaging code SMA				
Metal retaining clip	095.51			
Plastic retaining clip	095.52			

40



Approvals
(according to type):



- Rated values: 10 A - 250 V
- Insulation: ≥ 6 kV (1.2/50 μ s)
between coil and contacts
- Protection category: IP 20
- Ambient temperature: (-40...+70) $^{\circ}$ C

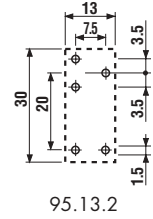
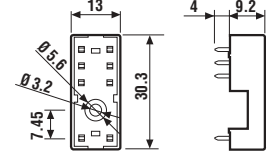
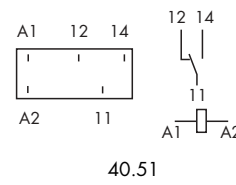
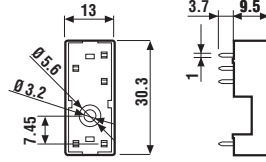
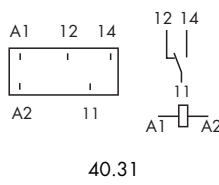

Copper side view

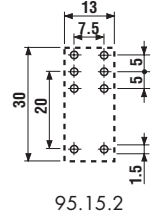
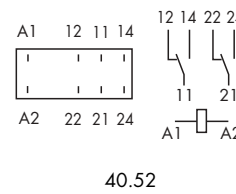

Copper side view

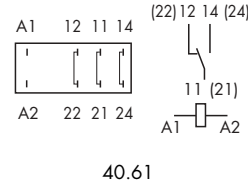

PACKAGING CODES

How to code and identify retaining clip and packaging options for sockets.

Code options according to the last three letters:

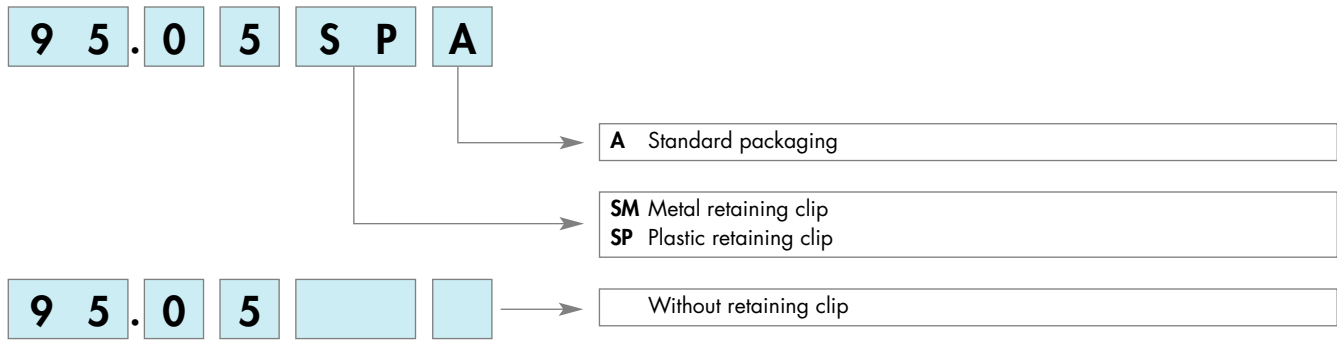



Relay type	41.31		41.52, 41.61	
Colour	BLUE	BLACK	BLUE	BLACK
P.C.B. socket retaining clip 095.41 supplied with socket packaging code SNA	95.13.2	95.13.20	95.15.2	95.15.20
Metal retaining clip	095.41			
Plastic retaining clip	095.42			

41

Approvals
(according to type):



- Rated values: 10 A - 250 V
- Insulation: ≥ 6 kV (1.2/50 μ s)
between coil and contacts
- Protection category: IP 20
- Ambient temperature: (-40...+70) $^{\circ}$ C

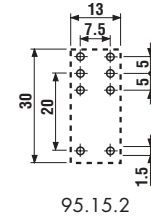
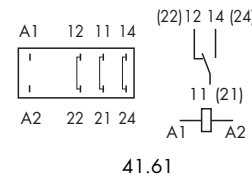
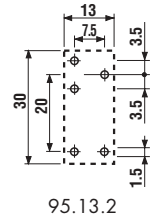
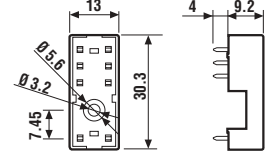
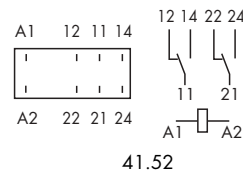
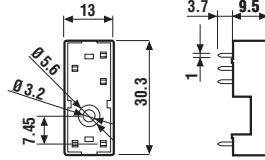
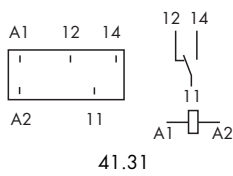

Copper side view

Copper side view

PACKAGING CODES

How to code and identify retaining clip and packaging options for sockets.

Code options according to the last three letters:

9 5 . 1 3 S N A

A Standard packaging

SN Metal retaining clip
SL Plastic retaining clip

9 5 . 1 3 [] []

Without retaining clip



95.23

Relay type	43.41	
Colour	BLUE	BLACK
P.C.B. socket (CO/SPDT only) retaining clip 095.43 supplied with socket packaging code SNA	95.23	95.23.0
Metal retaining clip	095.43	

Approvals
(according to type):



- 43** - Rated values: 10 A - 250 V
- Insulation: ≥ 6 kV (1.2/50 μ s) *between coil and contacts*
- Protection category: IP 20
- Ambient temperature: (-40...+70)°C

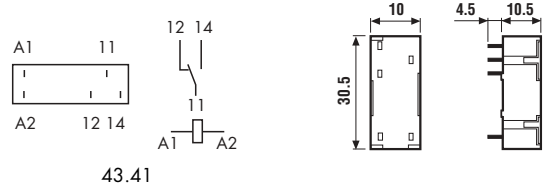

43.41

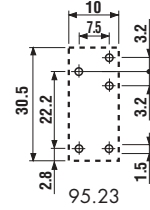

Copper side view

PACKAGING CODES

How to code and identify retaining clip and packaging options for sockets.

Code options according to the last three letters:

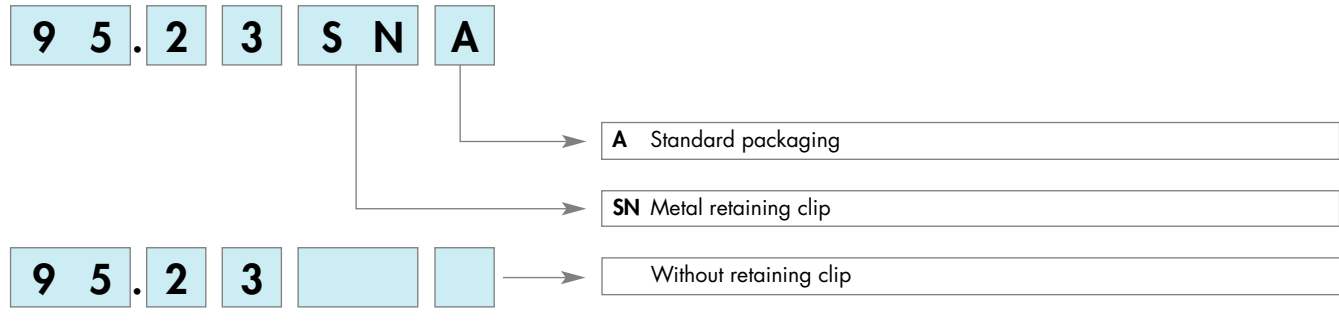



95.05

Approvals
(according to type):



Relay type	44.52, 44.62	
Colour	BLUE	BLACK
Clamp terminal socket: panel or 35 mm rail (EN 50022) mount retaining clip 095.01 supplied with socket packaging code SPA	95.05	95.05.0
Plastic retaining and release clip	095.01	095.01.0
Metal retaining clip	095.71	
8-way jumper link	095.18	095.18.0
Identification tag	095.00.4	
Modules (see table below)	99.02	
Timer modules (see table below)	86.10, 86.20	
Sheet of marker tags for retaining and release clip 095.01	060.72	

44

- Rated values: 10 A - 250 V
- Insulation: ≥ 6 kV (1.2/50 μ s) *between coil and contacts*
- Protection category: IP 20
- Ambient temperature: (-40...+70) $^{\circ}$ C
- \oplus Screw torque: 0.5 Nm
- Wire strip length: 8 mm
- Max wire size:

	solid wire	stranded wire
mm ²	1x6 / 2x2.5	1x4 / 2x2.5
AWG	1x10 / 2x14	1x12 / 2x14

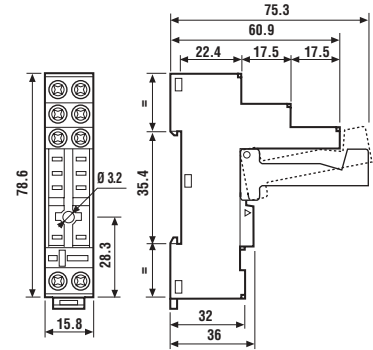

095.01



060.72

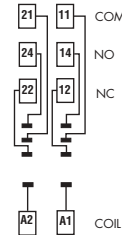

FOR 95.05 SOCKET:



095.18

8-way jumper link	095.18
--------------------------	--------

- Rated values: 10 A - 250 V

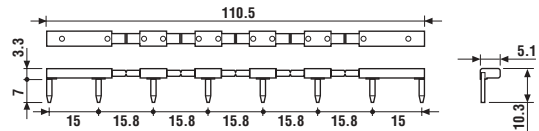

86.10

86 series module timers (see technical data pages 151/156)	BLUE
Mono-function: (12...24)V AC/DC; function AI; (1.5s...60min)	86.10.0.024.0000
Mono-function: (12...24)V AC/DC; function DI; (1.5s...60min)	86.20.0.024.0000

Approvals
(according to type): GOST



99.02

Approvals
(according to type):



99.02 coil indication and EMC suppression modules (see technical data page 209)	BLUE*
Diode** (+A1, standard polarity) (6...220)V DC	99.02.3.000.00
LED (6...24)V DC/AC	99.02.0.024.59
LED (28...60)V DC/AC	99.02.0.060.59
LED (110...240)V DC/AC	99.02.0.230.59
LED + Diode** (+A1, standard polarity) (6...24)V DC	99.02.9.024.99
LED + Diode** (+A1, standard polarity) (28...60)V DC	99.02.9.060.99
LED + Diode** (+A1, standard polarity) (110...220)V DC	99.02.9.220.99
LED + Varistor (6...24)V DC/AC	99.02.0.024.98
LED + Varistor (28...60)V DC/AC	99.02.0.060.98
LED + Varistor (110...240)V DC/AC	99.02.0.230.98
RC (6...24)V DC/AC	99.02.0.024.09
RC (28...60)V DC/AC	99.02.0.060.09
RC (110...240)V DC/AC	99.02.0.230.09
Residual current by-pass (62 k Ω /1W) (110...240)V AC	99.02.8.230.07

* Modules in Black housing are available on request.

**For DC supply, apply the positive to terminal A1.



95.85.3

Approvals
(according to type):



- Rated values: 10 A - 250 V
- Insulation: ≥ 6 kV (1.2/50 μ s) *between coil and contacts*
- Protection category: IP 20
- Ambient temperature: (-40...+70) $^{\circ}$ C
- Screw torque: 0.5 Nm
- Wire strip length: 7 mm
- Max wire size:

	solid wire	stranded wire
mm ²	1x6 / 2x2.5	1x4 / 2x2.5
AWG	1x10 / 2x14	1x12 / 2x14

Relay type	44.52, 44.62	
Colour	BLUE	BLACK
Clamp terminal socket: panel or 35 mm rail (EN 50022) mount retaining clip 095.91.3 supplied with socket packaging code SPA	95.85.3	95.85.30
Metal retaining clip	095.71	
Plastic retaining and release clip	095.91.3	
8-way jumper link	095.08	095.08.0
Modules (see table below)	99.80	
Sheet of marker tags for retaining and release clip 095.91.3	060.72	

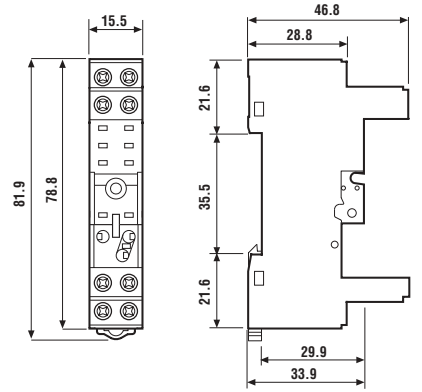
44

095.91.3

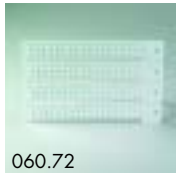

060.72

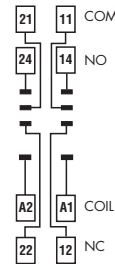

FOR 95.85.3 SOCKET:



095.08

8-way jumper link	095.08
--------------------------	--------

- Rated values: 10 A - 250 V

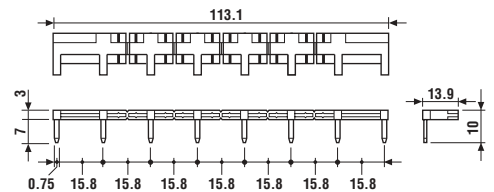

99.80

Approvals
(according to type):

GOST

* Modules in Black housing are available on request.

**For DC supply, apply the positive to terminal A1.

Green LED is standard.
Red LED available on request.

99.80 coil indication and EMC suppression modules (see technical data page 209)		BLUE*
Diode** (+A1, standard polarity)	(6...220)V DC	99.80.3.000.00
LED	(6...24)V DC/AC	99.80.0.024.59
LED	(28...60)V DC/AC	99.80.0.060.59
LED	(110...240)V DC/AC	99.80.0.230.59
LED + Diode** (+A1, standard polarity)	(6...24)V DC	99.80.9.024.99
LED + Diode** (+A1, standard polarity)	(28...60)V DC	99.80.9.060.99
LED + Diode** (+A1, standard polarity)	(110...220)V DC	99.80.9.220.99
LED + Varistor	(6...24)V DC/AC	99.80.0.024.98
LED + Varistor	(28...60)V DC/AC	99.80.0.060.98
LED + Varistor	(110...240)V DC/AC	99.80.0.230.98
RC circuit	(6...24)V DC/AC	99.80.0.024.09
RC circuit	(28...60)V DC/AC	99.80.0.060.09
RC circuit	(110...240)V DC/AC	99.80.0.230.09
Residual current by-pass (62 k Ω /1W)	(110...240)V AC	99.80.8.230.07



95.15.2

Approvals
(according to type):



- Rated values: 10 A - 250 V
- Insulation: ≥ 6 kV (1.2/50 μ s) *between coil and contacts*
- Protection category: IP 20
- Ambient temperature: (-40...+70) $^{\circ}$ C

Relay type	44.52, 44.62	
Colour	BLUE	BLACK
P.C.B. socket	95.15.2	95.15.20
retaining clip 095.51 supplied with socket with packaging code SMA		
Metal retaining clip	095.51	
Plastic retaining clip	095.52	

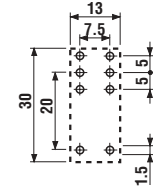
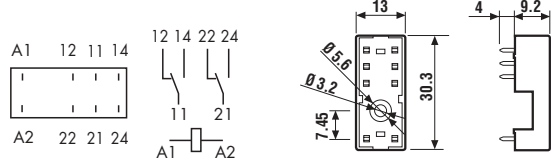

Copper side view

PACKAGING CODES

How to code and identify retaining clip and packaging options for sockets.

Code options according to the last three letters:

