

Features

Plug-in mount 10 A General purpose relay

- 2 & 3 pole changeover contacts
- Cadmium Free contacts (preferred version)
- AC coils & DC coils
- UL Listing (certain relay/socket combinations)
- Contact material options
- Lockable test button with mechanical flag indicator (preferred version)
- 90 series sockets
- Coil EMC suppression
- Timer accessories 86 series

60.12



- 2 pole, 10 A power contacts
- 8 pin plug-in

60.13



- 3 pole, 10 A power contacts
- 11 pin plug-in

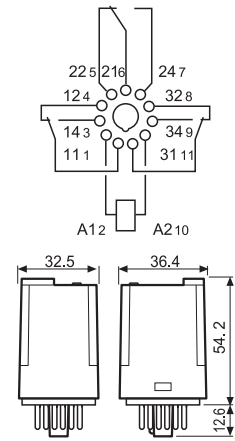
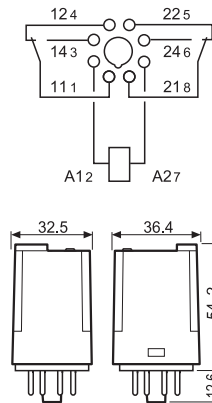

FOR UL HORSEPOWER AND PILOT DUTY RATINGS
SEE "General technical information" page V

| Contact specification | | 60.12 | 60.13 |
|--|-----------------|---|--|
| Contact configuration | | 2 CO (DPDT) | 3 CO (3PDT) |
| Rated current/Maximum peak current | A | 10/20 | 10/20 |
| Rated voltage/Maximum switching voltage | V AC | 250/400 | 250/400 |
| Rated load AC1 | VA | 2,500 | 2,500 |
| Rated load AC15 (230 V AC) | VA | 500 | 500 |
| Single phase motor rating (230 V AC) | kW | 0.37 | 0.37 |
| Breaking capacity DC1: 30/110/220 V | A | 10/0.4/0.15 | 10/0.4/0.15 |
| Minimum switching load | mW (V/mA) | 500 (10/5) | 500 (10/5) |
| Standard contact material | | AgNi | AgNi |
| Coil specification | | 60.12 | 60.13 |
| Nominal voltage (U _N) | V AC (50/60 Hz) | 6 - 12 - 24 - 48 - 60 - 110 - 120 - 230 - 240 - 400 | |
| | V DC | 6 - 12 - 24 - 48 - 60 - 110 - 125 - 220 | |
| Rated power AC/DC | VA (50 Hz)/W | 2.2/1.3 | 2.2/1.3 |
| Operating range | AC | (0.8...1.1)U _N | (0.8...1.1)U _N |
| | DC | (0.8...1.1)U _N | (0.8...1.1)U _N |
| Holding voltage | AC/DC | 0.8 U _N /0.5 U _N | 0.8 U _N /0.5 U _N |
| Must drop-out voltage | AC/DC | 0.2 U _N /0.1 U _N | 0.2 U _N /0.1 U _N |
| Technical data | | 60.12 | 60.13 |
| Mechanical life AC/DC | cycles | 20 · 10 ⁶ /50 · 10 ⁶ | 20 · 10 ⁶ /50 · 10 ⁶ |
| Electrical life at rated load AC1 | cycles | 200 · 10 ³ | 200 · 10 ³ |
| Operate/release time | ms | 9/9 | 9/9 |
| Insulation between coil and contacts (1.2/50 μs) | kV | 4 | 3.6 |
| Dielectric strength between open contacts | V AC | 1,000 | 1,000 |
| Ambient temperature range | °C | -40...+70 | -40...+70 |
| Environmental protection | | RT I | RT I |

Approvals (according to type)



Features

Plug-in mount - 6 A

Bifurcated contacts for low level switching

- 2 & 3 pole changeover contacts
- Cadmium Free contacts (Gold plated Silver Nickel)
- AC coils & DC coils
- Lockable test button with mechanical flag indicator (preferred version)
- 90 series sockets
- Coil EMC suppression
- Timer accessories 86 series

60.12 - 5200



- 2 pole, 6 A bifurcated contacts
- 8 pin plug-in

60.13 - 5200



- 3 pole, 6 A bifurcated contacts
- 11 pin plug-in

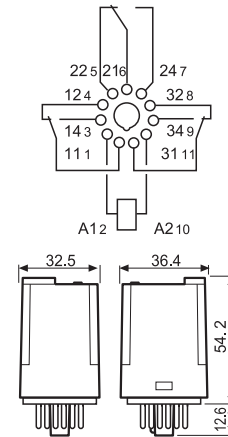
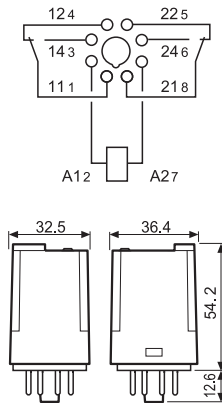

FOR UL HORSEPOWER AND PILOT DUTY RATINGS
SEE "General technical information" page V

| Contact specification | | | |
|--|-----------------|---|--|
| Contact configuration | | 2 CO (DPDT) | 3 CO (3PDT) |
| Rated current/Maximum peak current | A | 6/10 | 6/10 |
| Rated voltage/Maximum switching voltage | V AC | 250/400 | 250/400 |
| Rated load AC1 | VA | 1,500 | 1,500 |
| Rated load AC15 (230 V AC) | VA | 250 | 250 |
| Single phase motor rating (230 V AC) | kW | 0.185 | 0.185 |
| Breaking capacity DC1: 30/110/220 V | A | 6/0.3/0.12 | 6/0.3/0.12 |
| Minimum switching load | mW (V/mA) | 50 (5/5) | 50 (5/5) |
| Standard contact material | | AgNi + Au (5 µm) bifurcated contacts | AgNi + Au (5 µm) bifurcated contacts |
| Coil specification | | | |
| Nominal voltage (U _N) | V AC (50/60 Hz) | 6 - 12 - 24 - 48 - 60 - 110 - 120 - 230 - 240 - 400 | |
| | V DC | 6 - 12 - 24 - 48 - 60 - 110 - 125 - 220 | |
| Rated power AC/DC | VA (50 Hz)/W | 2.2/1.3 | 2.2/1.3 |
| Operating range | AC | (0.8...1.1)U _N | (0.8...1.1)U _N |
| | DC | (0.8...1.1)U _N | (0.8...1.1)U _N |
| Holding voltage | AC/DC | 0.8 U _N /0.5 U _N | 0.8 U _N /0.5 U _N |
| Must drop-out voltage | AC/DC | 0.2 U _N /0.1 U _N | 0.2 U _N /0.1 U _N |
| Technical data | | | |
| Mechanical life AC/DC | cycles | 20 · 10 ⁶ /50 · 10 ⁶ | 20 · 10 ⁶ /50 · 10 ⁶ |
| Electrical life at rated load AC1 | cycles | 250 · 10 ³ | 250 · 10 ³ |
| Operate/release time | ms | 9/9 | 9/9 |
| Insulation between coil and contacts (1.2/50 µs) | kV | 4 | 3.6 |
| Dielectric strength between open contacts | V AC | 1,000 | 1,000 |
| Ambient temperature range | °C | -40...+70 | -40...+70 |
| Environmental protection | | RT I | RT I |

Approvals (according to type)



Features

Flange mount - General purpose relay 10 A

- Faston 187, 4.8x0.8 mm
- 2 & 3 pole changeover contacts
- AC coils & DC coils
- Cadmium Free contacts (preferred version)
- Contacts material options

60.62



- 2 pole, 10 A power contacts
- Flange mount/Faston 187

60.63



- 3 pole, 10 A power contacts
- Flange mount/Faston 187

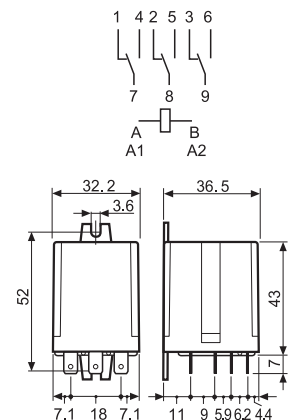
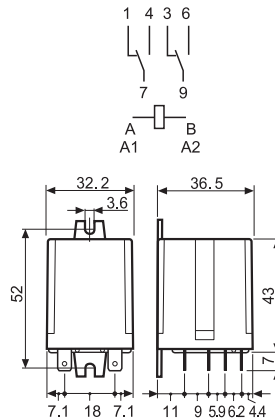

FOR UL HORSEPOWER AND PILOT DUTY RATINGS
SEE "General technical information" page V

| Contact specification | | 60.62 | 60.63 |
|--|-----------------|---|--|
| Contact configuration | | 2 CO (DPDT) | 3 CO (3PDT) |
| Rated current/Maximum peak current | A | 10/20 | 10/20 |
| Rated voltage/Maximum switching voltage | V AC | 250/400 | 250/400 |
| Rated load AC1 | VA | 2,500 | 2,500 |
| Rated load AC15 (230 V AC) | VA | 500 | 500 |
| Single phase motor rating (230 V AC) | kW | 0.37 | 0.37 |
| Breaking capacity DC1: 30/110/220 V | A | 10/0.4/0.15 | 10/0.4/0.15 |
| Minimum switching load | mW (V/mA) | 500 (10/5) | 500 (10/5) |
| Standard contact material | | AgNi | AgNi |
| Coil specification | | 60.62 | 60.63 |
| Nominal voltage (U _N) | V AC (50/60 Hz) | 6 - 12 - 24 - 48 - 60 - 110 - 120 - 230 - 240 - 400 | |
| | V DC | 6 - 12 - 24 - 48 - 60 - 110 - 125 - 220 | |
| Rated power AC/DC | VA (50 Hz)/W | 2.2/1.3 | 2.2/1.3 |
| Operating range | AC | (0.8...1.1)U _N | (0.8...1.1)U _N |
| | DC | (0.8...1.1)U _N | (0.8...1.1)U _N |
| Holding voltage | AC/DC | 0.8 U _N /0.5 U _N | 0.8 U _N /0.5 U _N |
| Must drop-out voltage | AC/DC | 0.2 U _N /0.1 U _N | 0.2 U _N /0.1 U _N |
| Technical data | | 60.62 | 60.63 |
| Mechanical life AC/DC | cycles | 20 · 10 ⁶ /50 · 10 ⁶ | 20 · 10 ⁶ /50 · 10 ⁶ |
| Electrical life at rated load AC1 | cycles | 200 · 10 ³ | 200 · 10 ³ |
| Operate/release time | ms | 9/9 | 9/9 |
| Insulation between coil and contacts (1.2/50 μs) | kV | 4 | 3.6 |
| Dielectric strength between open contacts | V AC | 1,000 | 1,000 |
| Ambient temperature range | °C | -40...+70 | -40...+70 |
| Environmental protection | | RT I | RT I |

Approvals (according to type)



Ordering information

Example: 60 series plug-in relay, 3 CO (3PDT), 12 V DC coil, test button and mechanical indicator.

| | | | | | | | | | | | | | | | | | |
|---|----------|--------------------------|----------|--|---|---|---|---|----------|--|---|---------------------------|----------|---|----------|----------------------------|----------|
| 6 | 0 | . | 1 | 3 | . | 9 | . | 0 | 1 | 2 | . | 0 | 0 | A | B | C | D |
| Series | | Type | | No. of poles | | Coil version | | Coil voltage | | A: Contact material | | B: Contact circuit | | C: Options | | D: Special versions | |
| 1 = 8/11 pin plug-in 6 = Faston 187 (4.8x0.8 mm) with flange mount | | 2 = 2 pole 3 = 3 pole | | 4 = Current sensing (60.12/13 only) 8 = AC (50/60 Hz) 9 = DC | | 0 = Standard 2 = AgCdO 5 = AgNi + Au (5 µm) | | 0 = CO (nPDT) 2 = Bifurcated contacts 60.12/13 - 6 A only | | 0 = None 2 = Mechanical indicator 3 = LED (AC) 4 = Lockable test button + mechanical indicator 5* = Lockable test button + LED (AC) 54* = Lockable test button + LED (AC) + mechanical indicator 6* = LED + diode (DC, polarity positive to pin 2) 7* = Lockable test button + LED + diode (DC, polarity positive to pin 2) 74* = Lockable test button + LED + diode (DC, polarity positive to pin 2) + mechanical indicator | | 0 = Standard | | * Options not available for 220 V DC and 400 V AC versions. | | | |

Selecting features and options: only combinations in the same row are possible.
Preferred selections for best availability are shown in **bold**.

| Type | Coil version | A | B | C | D |
|----------|-----------------|------------------|----------|--------------------------|----------|
| 60.12/13 | AC | 0 - 2 | 0 | 0 - 2 - 3 - 4 - 5 | 0 |
| | AC | 0 - 2 | 0 | 54 | / |
| | AC | 5 | 0 - 2 | 0 - 2 - 3 - 4 - 5 | 0 |
| | AC | 5 | 0 - 2 | 54 | / |
| | DC | 0 - 2 | 0 | 0 - 2 - 4 - 6 - 7 | 0 |
| | DC | 0 - 2 | 0 | 74 | / |
| | DC | 5 | 0 - 2 | 0 - 2 - 4 - 6 - 7 | 0 |
| | DC | 5 | 0 - 2 | 74 | / |
| | current sensing | 0 | 0 | 4 | 0 |
| 60.62/63 | AC-DC | 0 - 2 - 5 | 0 | 0 | 0 |

Descriptions: Options and Special versions

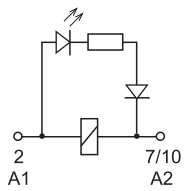

C: Option 3, 5, 54
LED (AC)

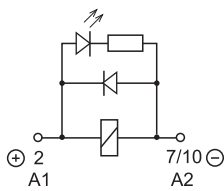

C: Option 6, 7, 74
LED + diode (DC, polarity positive to pin 2)



Lockable test button and mechanical flag indicator (0040, 0050, 0054, 0070, 0074)

The dual-purpose Finder test button can be used in two ways:

Case 1) The plastic pip (located directly above the test button) remains intact. In this case, when the test button is pushed, the contacts operate. When the test button is released the contacts return to their former state.

Case 2) The plastic pip is broken-off (using an appropriate cutting tool). In this case, (in addition to the above function), when the test button is pushed and rotated, the contacts are latched in the operating state, and remain so until the test button is rotated back to its former position. In both cases ensure that the test button actuation is swift and decisive.

Technical data

| Insulation according to EN 61810-1 | | 2 pole | | 3 pole | |
|---|--------------------------|---------------------|--------------------|---------------------|-----|
| Nominal voltage of supply system | V AC | 230/400 | | 230/400 | |
| Rated insulation voltage | V AC | 250 | 400 | 250 | 400 |
| Pollution degree | | 3 | 2 | 3 | 2 |
| Insulation between coil and contact set | | | | | |
| Type of insulation | | Basic | | Basic | |
| Overvoltage category | | III | | III | |
| Rated impulse voltage | kV (1.2/50 μ s) | 4 | | 3.6 | |
| Dielectric strength | V AC | 2,000 | | 2,000 | |
| Insulation between adjacent contacts | | | | | |
| Type of insulation | | Basic | | Basic | |
| Overvoltage category | | III | | III | |
| Rated impulse voltage | kV (1.2/50 μ s) | 4 | | 3.6 | |
| Dielectric strength | V AC | 2,000 | | 2,000 | |
| Insulation between open contacts | | | | | |
| Type of disconnection | | Micro-disconnection | | Micro-disconnection | |
| Dielectric strength | V AC/kV (1.2/50 μ s) | 1,000/1.5 | | 1,000/1.5 | |
| Conducted disturbance immunity | | | | | |
| Burst (5...50)ns, 5 kHz, on A1 - A2 | | EN 61000-4-4 | | level 4 (4 kV) | |
| Surge (1.2/50 μ s) on A1 - A2 (differential mode) | | EN 61000-4-5 | | level 4 (4 kV) | |
| Other data | | | | | |
| Bounce time: NO/NC | ms | 2/4 | | | |
| Vibration resistance (5...55)Hz: NO/NC | g | 22/22 | | | |
| Shock resistance | g | 20 | | | |
| Power lost to the environment | without contact current | W | 1.3 | 1.3 | |
| | with rated current | W | 2.7 (60.12, 60.62) | 3.4 (60.13, 60.63) | |

Contact specification

F 60 - Electrical life (AC) v contact current

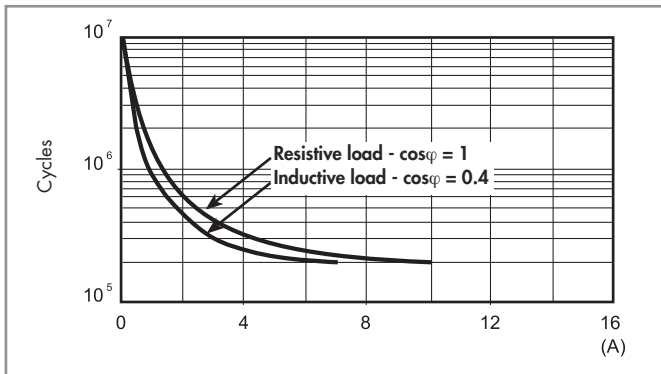

H 60 - Maximum DC1 breaking capacity

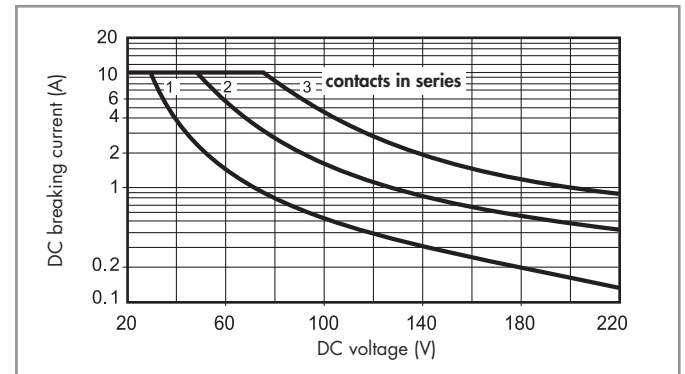

- When switching a resistive load (DC1) having voltage and current values under the curve, an electrical life of $\geq 100 \cdot 10^3$ can be expected.
- In the case of DC13 loads, the connection of a diode in parallel with the load will permit a similar electrical life as for a DC1 load.
Note: the release time for the load will be increased.

Coil specifications

DC coil data

| Nominal voltage U_N V | Coil code | Operating range | | Resistance R Ω | Rated coil consumption I at U_N mA |
|-------------------------------|-----------|-----------------|----------------|-----------------------------|--|
| | | U_{min} V | U_{max} V | | |
| 6 | 9.006 | 4.8 | 6.6 | 28 | 214 |
| 12 | 9.012 | 9.6 | 13.2 | 110 | 109 |
| 24 | 9.024 | 19.2 | 26.4 | 445 | 53.9 |
| 48 | 9.048 | 38.4 | 52.8 | 1,770 | 27.1 |
| 60 | 9.060 | 48 | 66 | 2,760 | 21.7 |
| 110 | 9.110 | 88 | 121 | 9,420 | 11.7 |
| 125 | 9.125 | 100 | 138 | 12,000 | 10.4 |
| 220 | 9.220 | 176 | 242 | 37,300 | 5.8 |

AC coil data

| Nominal voltage U_N V | Coil code | Operating range | | Resistance R Ω | Rated coil consumption I at U_N (50Hz) mA |
|-------------------------------|-----------|-----------------|----------------|-----------------------------|---|
| | | U_{min} V | U_{max} V | | |
| 6 | 8.006 | 4.8 | 6.6 | 4.6 | 367 |
| 12 | 8.012 | 9.6 | 13.2 | 19 | 183 |
| 24 | 8.024 | 19.2 | 26.4 | 74 | 90 |
| 48 | 8.048 | 38.4 | 52.8 | 290 | 47 |
| 60 | 8.060 | 48 | 66 | 450 | 37 |
| 110 | 8.110 | 88 | 121 | 1,600 | 20 |
| 120 | 8.120 | 96 | 132 | 1,940 | 18.6 |
| 230 | 8.230 | 184 | 253 | 7,250 | 10.5 |
| 240 | 8.240 | 192 | 264 | 8,500 | 9.2 |
| 400 | 8.400 | 320 | 440 | 19,800 | 6 |

Coil specifications

R 60 - DC coil operating range v ambient temperature

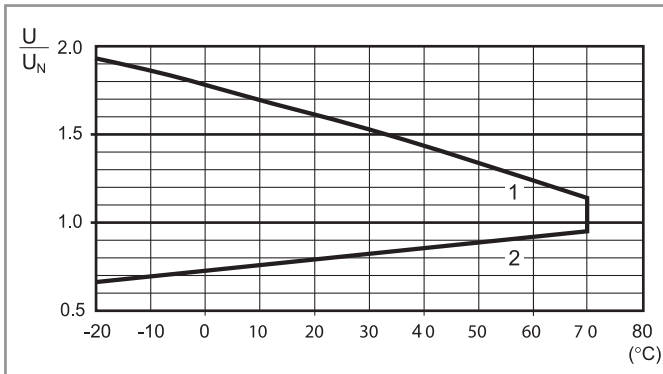

- 1 - Max. permitted coil voltage.
- 2 - Min. pick-up voltage with coil at ambient temperature.

R 60 - AC coil operating range v ambient temperature

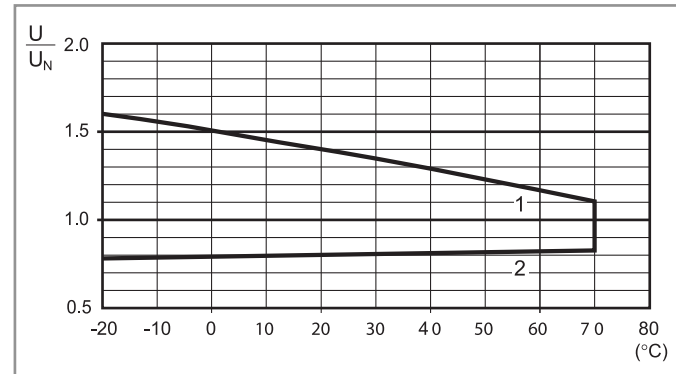

- 1 - Max. permitted coil voltage.
- 2 - Min. pick-up voltage with coil at ambient temperature.

Current sensing version

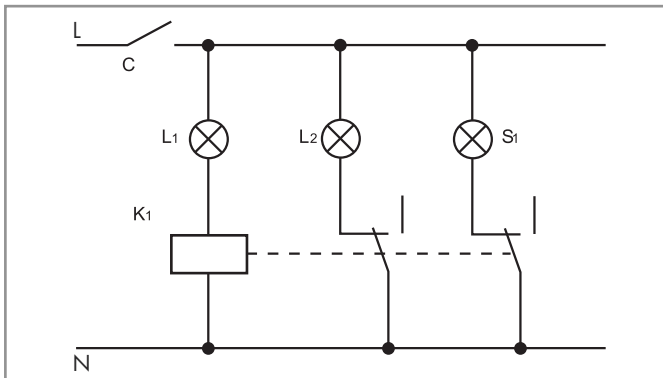

Typical application with current sensing relays.
An open circuit filament of lamp L1 is detected by the current sensing relay coil (K1) which causes the back-up safety lamp L2 to be energised, and indication of failure at the control panel via lamp S1.

Example: navigation light.

- L1 = Light
- L2 = Safety light
- S1 = Control light
- K1 = Relay

Current sensing DC coil data

| Coil code | I_{min} (A) | I_N (A) | I_{max} (A) | R (Ω) |
|-----------|---------------|-----------|---------------|----------------|
| 4202 | 1.7 | 2.0 | 2.4 | 0.15 |
| 4182 | 1.5 | 1.8 | 2.2 | 0.19 |
| 4162 | 1.4 | 1.6 | 1.9 | 0.24 |
| 4142 | 1.2 | 1.4 | 1.7 | 0.31 |
| 4122 | 1.0 | 1.2 | 1.4 | 0.42 |
| 4102 | 0.85 | 1.0 | 1.2 | 0.61 |
| 4092 | 0.8 | 0.9 | 1.1 | 0.75 |
| 4062 | 0.5 | 0.6 | 0.7 | 1.70 |
| 4032 | 0.25 | 0.3 | 0.4 | 6.70 |
| 4012 | 0.085 | 0.1 | 0.15 | 61 |

Current sensing AC coil data

| Coil code | I_{min} (A) | I_N (A) | I_{max} (A) | R (Ω) |
|-----------|---------------|-----------|---------------|----------------|
| 4251 | 2.1 | 2.5 | 3.0 | 0.05 |
| 4181 | 1.5 | 1.8 | 2.2 | 0.10 |
| 4161 | 1.4 | 1.6 | 1.9 | 0.12 |
| 4121 | 1.0 | 1.2 | 1.4 | 0.22 |
| 4101 | 0.85 | 1.0 | 1.2 | 0.32 |
| 4051 | 0.42 | 0.5 | 0.6 | 1.28 |
| 4041 | 0.34 | 0.4 | 0.5 | 2.00 |
| 4031 | 0.25 | 0.3 | 0.4 | 3.57 |
| 4021 | 0.17 | 0.2 | 0.25 | 8.0 |
| 4011 | 0.085 | 0.1 | 0.15 | 32.1 |

Other types of current sensing relays are available on request.

Accessories

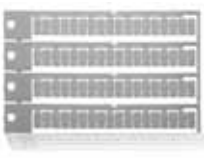

060.72

Sheet of marker tags for relay types 60.12 and 60.13, plastic, 72 tags, 6x12 mm

060.72



| Module | Socket | Relay | Description | Mounting | Accessories |
|--------|--------|-------|---|---|---|
| 99.02 | 90.02 | 60.12 | Screw terminal (Box clamp) socket Double A1 terminal | Panel or 35 mm rail (EN 60715) mount | <ul style="list-style-type: none"> - Coil indication and EMC suppression modules - Jumper link - Timer modules - Metal retaining clip |
| | 90.03 | 60.13 | | | |



| Module | Socket | Relay | Description | Mounting | Accessories |
|--------|--------|-------|-----------------------------------|---|---|
| 99.01 | 90.20 | 60.12 | Screw terminal (Box clamp) socket | Panel or 35 mm rail (EN 60715) mount | <ul style="list-style-type: none"> - Coil indication and EMC suppression modules - Metal retaining clip |
| | 90.21 | 60.13 | | | |



| Module | Socket | Relay | Description | Mounting | Accessories |
|--------|---------|-------|-----------------------------------|---|------------------------|
| — | 90.82.3 | 60.12 | Screw terminal (Box clamp) socket | Panel or 35 mm rail (EN 60715) mount | - Metal retaining clip |
| — | 90.83.3 | 60.13 | | | |



| Module | Socket | Relay | Description | Mounting | Accessories |
|--------|--------|-------|-----------------------------------|---|------------------------|
| — | 90.22 | 60.12 | Screw terminal (Box clamp) socket | Panel or 35 mm rail (EN 60715) mount | - Metal retaining clip |
| — | 90.23 | 60.13 | | | |

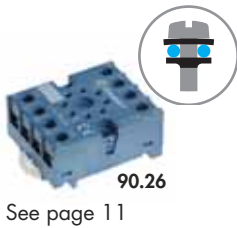

| Module | Socket | Relay | Description | Mounting | Accessories |
|--------|--------|-------|-------------------------------------|---|------------------------|
| — | 90.26 | 60.12 | Screw terminal (Plate clamp) socket | Panel or 35 mm rail (EN 60715) mount | - Metal retaining clip |
| — | 90.27 | 60.13 | | | |



| Module | Socket | Relay | Description | Mounting | Accessories |
|--------|--------|-------|----------------------------|-----------------|-------------|
| — | 90.12 | 60.12 | Flange mount solder socket | M3 screw fixing | — |
| — | 90.13 | 60.13 | | | |



| Module | Socket | Relay | Description | Mounting | Accessories |
|--------|---------|-------|-------------|----------|-------------|
| — | 90.14 | 60.12 | PCB socket | PCB | — |
| — | 90.14.1 | 60.12 | | | |
| — | 90.15 | 60.13 | | | |
| — | 90.15.1 | 60.13 | | | |

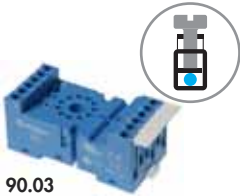

90.03

Approvals (according to type):



Certain relay/socket combinations

| Screw terminal (Box clamp) socket panel or 35 mm rail (EN 60715) mount For relay type | 90.02 Blue | 90.02.0 Black | 90.03 Blue | 90.03.0 Black |
|---|-----------------------------|------------------|---------------|------------------|
| Accessories | | | | |
| Metal retaining clip | | | 090.33 | |
| 6-way jumper link | | | 090.06 | |
| Identification tag | | | 090.00.2 | |
| Modules (see table below) | | | 99.02 | |
| Timer modules (see table below) | | | 86.00, 86.30 | |
| Technical data | | | | |
| Rated values | 10 A - 250 V | | | |
| Dielectric strength | 2 kV AC | | | |
| Protection category | IP 20 | | | |
| Ambient temperature | °C -40...+70 | | | |
| Screw torque | Nm 0.6 | | | |
| Wire strip length | mm 10 | | | |
| Max. wire size for 90.02 and 90.03 sockets | solid wire | | stranded wire | |
| | mm ² 1x6 / 2x2.5 | | 1x4 / 2x2.5 | |
| | AWG 1x10 / 2x14 | | 1x12 / 2x14 | |

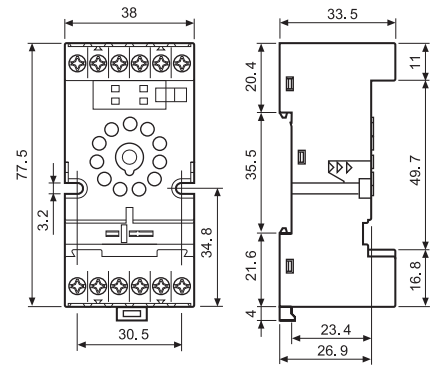
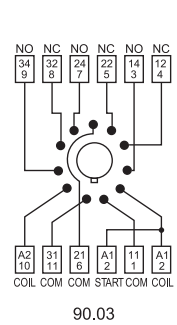
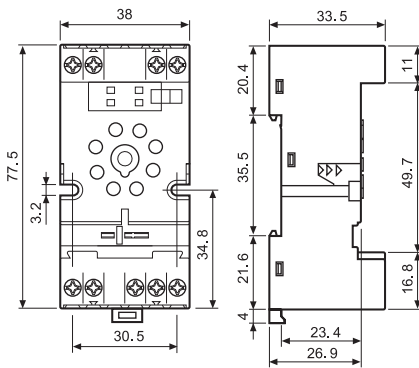
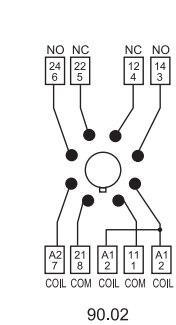

090.06

| | |
|--|---------------|
| 6-way jumper link for 90.02 and 90.03 sockets | 090.06 (blue) |
| Rated values | 10 A - 250 V |

Approvals (according to type):

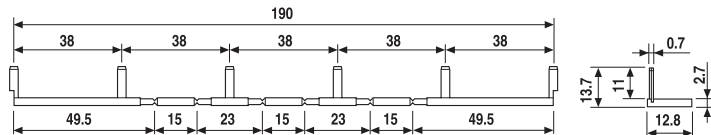

86.00



86.30

| 86 series timer modules | |
|---|------------------|
| Multi-voltage: (12...240)V AC/DC; | |
| Multi-functions: AI, DI, SW, BE, CE, DE, EE, FE; (0.05 s...100 h) | 86.00.0.240.0000 |
| (12...24)V AC/DC; Bi-function: AI, DI; (0.05 s...100 h) | 86.30.0.024.0000 |
| (110...125)V AC; Bi-function: AI, DI; (0.05s...100h) | 86.30.8.120.0000 |
| (230...240)V AC; Bi-function: AI, DI; (0.05 s...100 h) | 86.30.8.240.0000 |

Approvals (according to type):



99.02

Approvals (according to type):



| 99.02 coil indication and EMC suppression modules for 90.02 and 90.03 sockets | | |
|--|--------------------|----------------|
| Diode (+A1, standard polarity) | (6...220)V DC | 99.02.3.000.00 |
| LED | (6...24)V DC/AC | 99.02.0.024.59 |
| LED | (28...60)V DC/AC | 99.02.0.060.59 |
| LED | (110...240)V DC/AC | 99.02.0.230.59 |
| LED + Diode (+A1, standard polarity) | (6...24)V DC | 99.02.9.024.99 |
| LED + Diode (+A1, standard polarity) | (28...60)V DC | 99.02.9.060.99 |
| LED + Diode (+A1, standard polarity) | (110...220)V DC | 99.02.9.220.99 |
| LED + Varistor | (6...24)V DC/AC | 99.02.0.024.98 |
| LED + Varistor | (28...60)V DC/AC | 99.02.0.060.98 |
| LED + Varistor | (110...240)V DC/AC | 99.02.0.230.98 |
| RC circuit | (6...24)V DC/AC | 99.02.0.024.09 |
| RC circuit | (28...60)V DC/AC | 99.02.0.060.09 |
| RC circuit | (110...240)V DC/AC | 99.02.0.230.09 |
| Residual current by-pass | (110...240)V AC | 99.02.8.230.07 |

DC Modules with non-standard polarity (+A2) on request.



90.83.3

Approvals (according to type):



| Screw terminal (Box clamp) socket panel or 35 mm rail (EN 60715) mount For relay type | 90.82.3 Blue | 90.82.30 Black | 90.83.3 Blue | 90.83.30 Black |
|---|---------------------------|-------------------|-----------------|-------------------|
| For relay type | 60.12 | | 60.13 | |
| Accessories | | | | |
| Metal retaining clip | 090.33 | | | |
| Technical data | | | | |
| Rated values | 10 A - 250 V | | | |
| Dielectric strength | 2 kV AC | | | |
| Protection category | IP 20 | | | |
| Ambient temperature | °C -40...+70 | | | |
| ⊕ Screw torque | Nm 0.8 | | | |
| Max. wire size for 90.82.3 and 90.83.3 sockets | solid wire | | stranded wire | |
| | mm ² 1x6 / 2x4 | | 1x6 / 2x4 | |
| | AWG 1x10 / 2x14 | | 1x10 / 2x14 | |

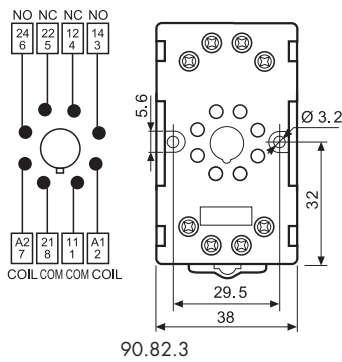

90.82.3

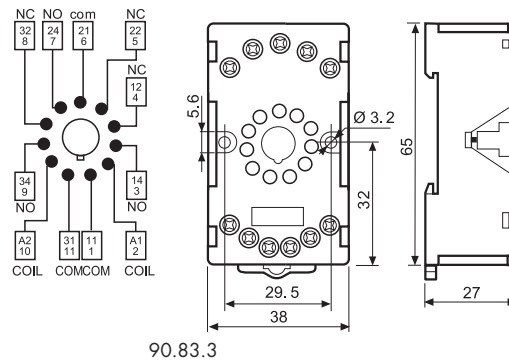

90.83.3



90.23

Approvals (according to type):



| Screw (Box clamp) terminal socket panel or 35 mm rail (EN 60715) mount For relay type | 90.22 Blue | 90.23 Blue |
|---|-----------------------------|---------------|
| For relay type | 60.12 | 60.13 |
| Accessories | | |
| Metal retaining clip (supplied with socket - packaging code SMA) | 090.33 | |
| Technical data | | |
| Rated values | 10 A - 250 V | |
| Dielectric strength | 2 kV AC | |
| Protection category | IP 20 | |
| Ambient temperature | °C -40...+70 | |
| ⊕ Screw torque | Nm 0.5 | |
| Wire strip length | mm 7 | |
| Max wire size for 90.22 and 90.23 sockets | solid wire | |
| | mm ² 1x6 / 2x2.5 | |
| | AWG 1x10 / 2x14 | |
| | | stranded wire |
| | | 1x6 / 2x2.5 |
| | | 1x10 / 2x14 |

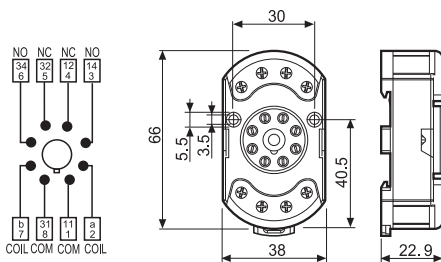

90.22

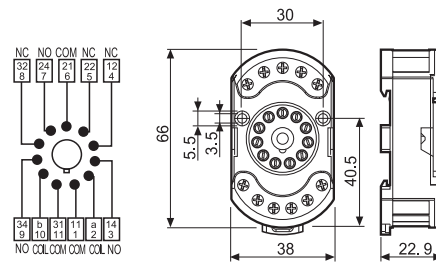

90.23

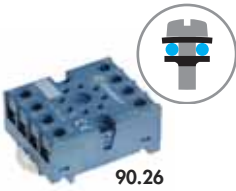

90.26

Approvals
(according to type):



| | | | | |
|--|-----------------|----------------|---------------|----------------|
| Screw terminal (Plate clamp) socket | 90.26 | 90.26.0 | 90.27 | 90.27.0 |
| panel or 35 mm rail (EN 60715) mount | Blue | Black | Blue | Black |
| For relay type | 60.12 | | 60.13 | |
| Accessories | | | | |
| Metal retaining clip (supplied with socket - packaging code SMA) | | | 090.33 | |
| Technical data | | | | |
| Rated values | 10 A - 250 V | | | |
| Dielectric strength | 2 kV AC | | | |
| Protection category | IP 20 | | | |
| Ambient temperature | °C -40...+70 | | | |
| Screw torque | Nm | 0.8 | | |
| Wire strip length | mm | 10 | | |
| Max. wire size for 90.26 and 90.27 sockets | | solid wire | stranded wire | |
| | mm ² | 1x4 / 2x2.5 | | 1x4 / 2x2.5 |
| | AWG | 1x12 / 2x14 | | 1x12 / 2x14 |

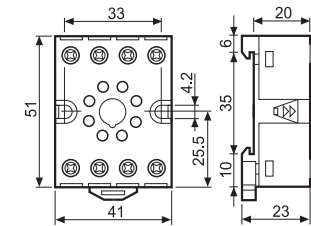

90.26

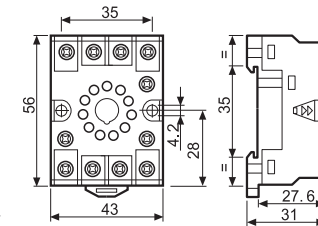
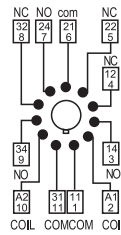

90.27



90.12

Approvals
(according to type):



| | | |
|-----------------------------------|----------------------|----------------------|
| Flange mount solder socket | 90.12 (black) | 90.13 (black) |
| mount with M3 screw | | |
| For relay type | 60.12 | 60.13 |
| Technical data | | |
| Rated values | 10 A - 250 V | |
| Dielectric strength | 2 kV AC | |
| Ambient temperature | °C -40...+70 | |

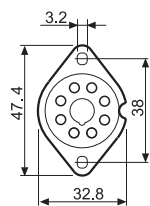

90.12

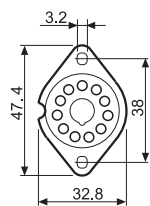

90.13

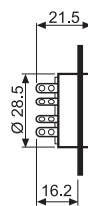



90.15

Approvals
(according to type):



| | | | |
|-----------------------|------|---------------------|-------------------|
| PCB socket | Blue | 90.14 (Ø 20.5 mm) | 90.15 (Ø 22 mm) |
| | Blue | 90.14.1 (Ø 17.5 mm) | 90.15.1 (Ø 19 mm) |
| For relay type | | 60.12 | 60.13 |
| Technical data | | | |
| Rated values | | 10 A - 250 V | |
| Dielectric strength | | 2 kV AC | |
| Ambient temperature | °C | -40...+70 | |

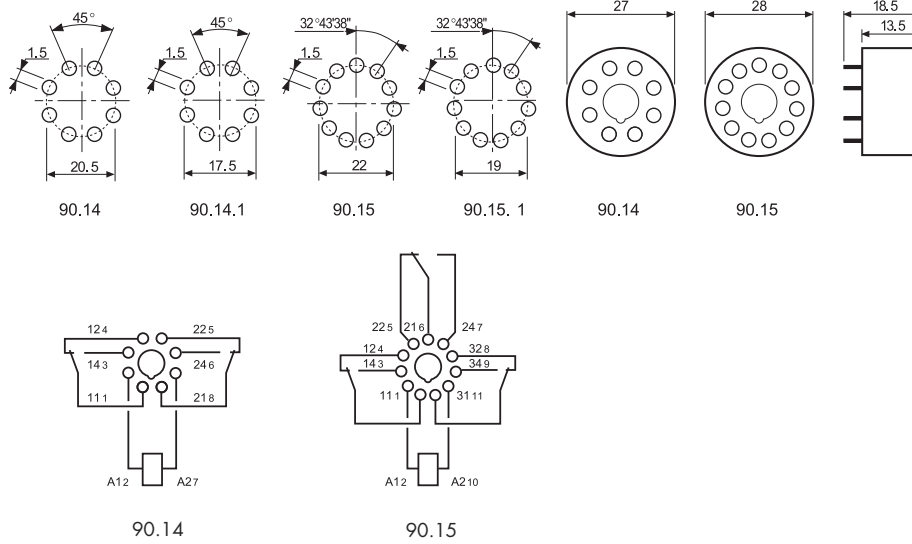

Packaging code

How to code and identify retaining clip and packaging options for sockets.

Example:

9 0 . 2 1 S M A

A Standard packaging

SM Metal retaining clip

9 0 . 2 1 [] []

Without retaining clip